

SL6+ manual

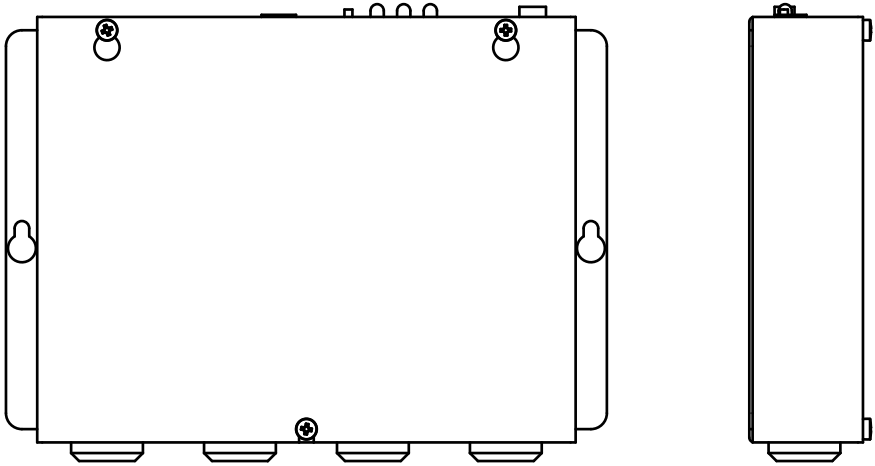

Technical data

Technical data main unit

Power	Supply voltage: 230 VAC, 50 Hz, min: 6,4 W, max: 9,4 W
Battery	Battery voltage: 12 VDC lead battery Capacity: 1,2 Ah Charge: 13,65 VDC, max. 200 mA
Emergency light	Emergency light output: 12 VDC max 500 mA
Emergency signal	Acoustic emergency signal output: 12 VDC max 200 mA
Inputs	10-30 VDC, 5 mA, optically isolated
Antenna connector	SMA (female)
Size (H x W x D)	SL6+: 160 x 241 x 47 mm, SL6+ Mini: 113 x 244 x 52 mm
Weight	1.7 kg
Relay outputs	Max 1 A/30 VDC. volt free relay outputs.
IP code	IP20
Audio files	Format WAVE-8 or 16kHz, 16 bit mono, max 16 sec/file
Bluetooth	Bluetooth 4.0, BLE 2,4 GHz, (2402 - 2480 MHz), Max 2dBm
Operating temperature	+5 C° – +40 C°
Air humidity	30% – 90% RH
Interface Boards	<p>*SL6-GSM-BOARD:</p> <ul style="list-style-type: none">- Micro SIM, 15 x 12 x 0,76 mm- Supports 2G (800/900/1800/2100/2600 MHz)- Requires SW 3.40 or later <p>*GSM-R/EGSM900/GSM1800</p> <ul style="list-style-type: none">- RF output power: Class 4 [2 W] for GSM-R/EGSM-R/EGSM900, Class 1 [1 W] for GSM1800 <p>*IF-BOARD-4G</p> <ul style="list-style-type: none">- Micro SIM, 15 x 12 x 0,76 mm- Supports 2G, 3G and 4G (800/900/1800/2100/2600 MHz)- Requires SW 4.92 or later <p>This product is intended for use in EMEA countries.</p>

Technical data voice station

Power	Supply voltage: 12 VDC, current drain nominal 15 mA
Inputs	10-30 VDC, 5 mA, optically isolated
Pictogram outputs	Max 100 mA, 24 VDC, transistor outputs, open collector
IP code	COP: IP00 COP2, Surface- or flush mounted units: IP40 To reach safety level IP4X, suitable additional protection have to be installed onsite.
Max cable length	0,22 mm ² cable: 100 m 0,75 mm ² cable: 250 m

Content

General information	4
Overview	5
Description of the bus system	5
System overview	5
Overview SL6+ main unit	6
Overview SL6+ voice station	7
SL6-4G-UE	9
Installation	10
Mounting	10
Wiring diagram SL6+ main unit	12
Wiring diagram voice station	13
Wiring diagram voice station screw terminals	13
Connecting the telephone line	14
Activating the SIM card	15
Bluetooth LED indication	15
LED indication front panel	16
LED indication for pictogram in car	17
Startup	18
Startup procedure	18
Configuration	19
Configuration overviews	19
Remote configuration with telephone/calling the SL6: step 1	21
Remote configuration with telephone: step 2	22
Initiate a restart from remote	23
On-site configuration with telephone	23
Configuration examples	24
Parameter list	25
Relay functions	32
Operating	33
Collective fault	33
Calling with SafeLine SL6+	34
Intercom between main unit and voice station	35
Outgoing call	35
Emergency calling process	36
Fallback	37
Fallback LMS codes	39
Fire mode	40
Service	41
Battery function	41
Troubleshooting main unit	42
Troubleshooting voice station	44
Related test Procedures	45
Internal operational failures	46
Declaration of Conformity	47

General information

This unit was built with state-of-the-art technology and to generally recognised safety related technical standards currently applicable. These installation instructions are to be followed by all people working with the unit, in both installation and maintenance.

It is extremely important that these installation instructions are made available at all times to the relevant technicians, engineers or servicing and maintenance personnel. The basis prerequisite for safe handling and trouble free operation of this system is a sound knowledge of the basic and special safety regulations concerning conveyor technology, and elevators in particular. The unit may only be used for its intended purpose. Note in particular that, no unauthorised changes or additions may be made inside the unit or individual components.

Exclusion of liability

The manufacturer is not liable with respect to the buyer of this product or to third parties for damage, loss, costs or work incurred as a result of accidents, misuse of the product, incorrect installation or illegal changes, repairs or additions. Claims under warranty are likewise excluded in such cases. The technical data is the latest available. The manufacturer accepts no liability arising from printing errors, mistakes or changes.

Declaration of conformity

Download "The declaration of conformity" at our website: www.safeline-group.com

Safety Precautions!

- Only trained professionals, who are authorised to work on the equipment, should install and configure this product.
- This quality product is dedicated for the lift industry. It has been designed and manufactured to be used for its specified purpose only. If it is to be used for any other purpose, SafeLine must be contacted in advance.
- It should not be modified or altered in any way, and should only be installed and configured strictly following the procedures described in this manual.
- All applicable health and safety requirements and equipment standards should be considered and strictly adhered to when installing and configuring this product.
- After installation and configuration this product and the operation of the equipment should be fully tested to ensure correct operation before the equipment is returned to normal use.

Electrical and electronic products may contain materials, parts and units that can be dangerous for the environment and human health. Please inform yourself about the local rules and disposal collection system for electrical and electronic products. The correct disposal of your old product will help to prevent negative consequences for the environment and human health.



Overview

Description of the bus system

The SL6+ system consists of a main unit and up to six connected voice stations. The system is based on a two-way system according to EN 81-28 and uses a bus system for communication between main unit and stations.

The bus system consists of four wires: two for transferring voice and data, and two for power supply.

Use the address selector to set a unique address for each station, ranging from 1-6. It is important that each station have a unique address set so the system is able to reach all specific voice stations.

System overview

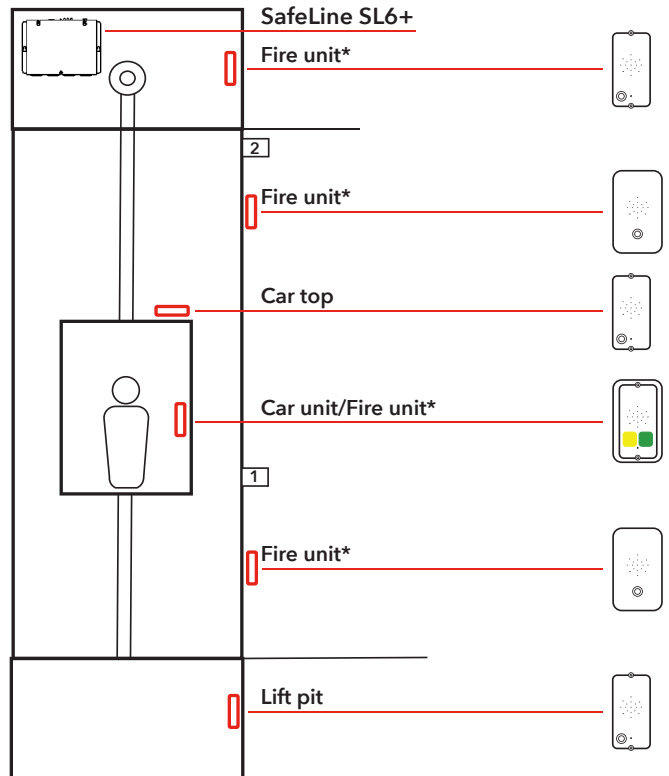

* Fire unit optional placement

Overview SL6+ main unit

- 1. Bluetooth LED**
- 2. RJ12 connector for optional telephone handset**
For configuration and intercom communication. Can also be used for external calls. Any standard analogue tone dial telephone can be used.
- 3. Reset button**
 - Reset all alarms.
 - Terminates a phone call in progress.
 - Triggers self test.
 - Activates display of GSM signal strength.
 - Triggers battery test.
- 4. LED indicators**
 - a. Mains power
 - b. Active alarm/battery status
 - c. PSTN/GSM net call status
- 5. USB Mini B PC connection**
For firmware update and configuration.
- 6. RS232 PC connection**
For configuration.
- 7. Screw terminal for optional telephone handset**
For configuration and inter-com communication. Can also be used for external calls. Any standard analogue tone dial telephone can be used.
- 8. Slot for optional card CANopen-Lift (*SL6-CAN-BOARD)**
- 9. Connector for external system speaker**
- 10. Input LED**
Green LEDs on when the input is active.
- 11. Relay LED**
Yellow LEDs on when the relay is active.
- 12. GND**
- 13. Terminals**
- 14. 12 V Battery, 1,2 Ah**
- 15. Slot for GSM interface board**

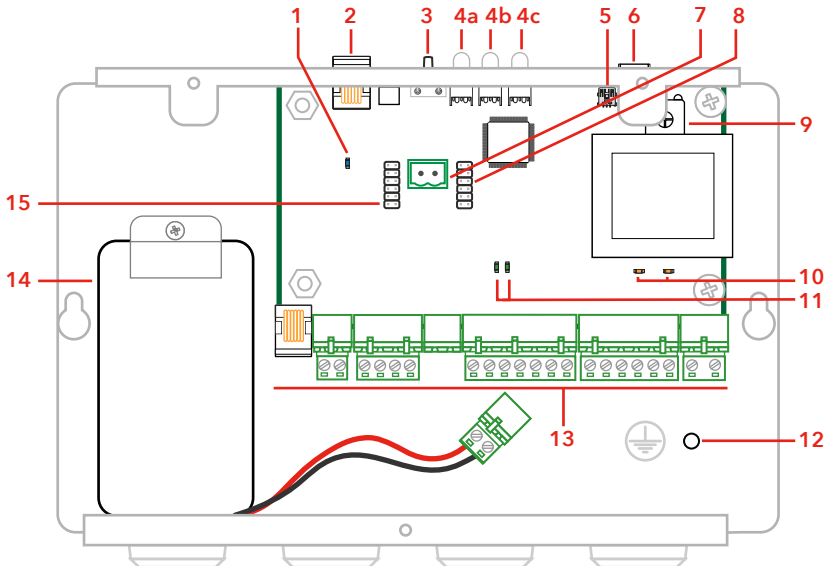

Overview SL6+ voice station

1. **Local button***
Only N/O. Connected with *CABLE13.
 2. **Screw connector terminals***
 3. **Emergency light***
Is connected with *CABLE13.
 4. **Hearing loop***
Is connected with *CABLE13.
 5. **RS232 PC connection**
For firmware update.
 6. **Terminal RJ45**
Input/output, bus connection, power and external pictogram.
 7. **Address selector**
Selects the bus address for the unit.
 8. **Volume control**
 9. **Pictogram yellow**
 10. **Microphone**
 11. **Pictogram green**
- * **NOTE:** This connection may not be present depending on your product.

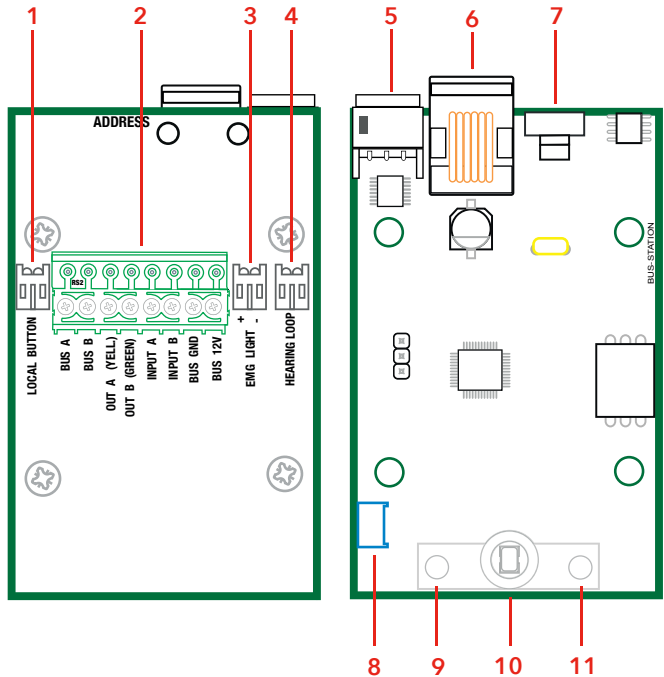

Default address setting:

Address	Unit
1	Car unit
2	Top unit
3	Lift pit unit
4	Fire unit
5	Fire unit
6	Fire unit

Change the default address settings using SafeLine Pro or SafeLine LYNX.

Overview SL6+ voice station SLB3

- 1. Address selector**
Fixed value, set to address 1 (car unit).
To change address to 2, use a utility knife to cut the thin wire marked with "Address: 1".
- 2. Connections**
- 3. Pictogram output**
- 4. Additional alarm button, N/O**
- 5. RS232 PC connection**
- 6. Volume control**
- 7. Emergency light, only for SLB-SM-Pic-Light**
- 8. Hearing loop**

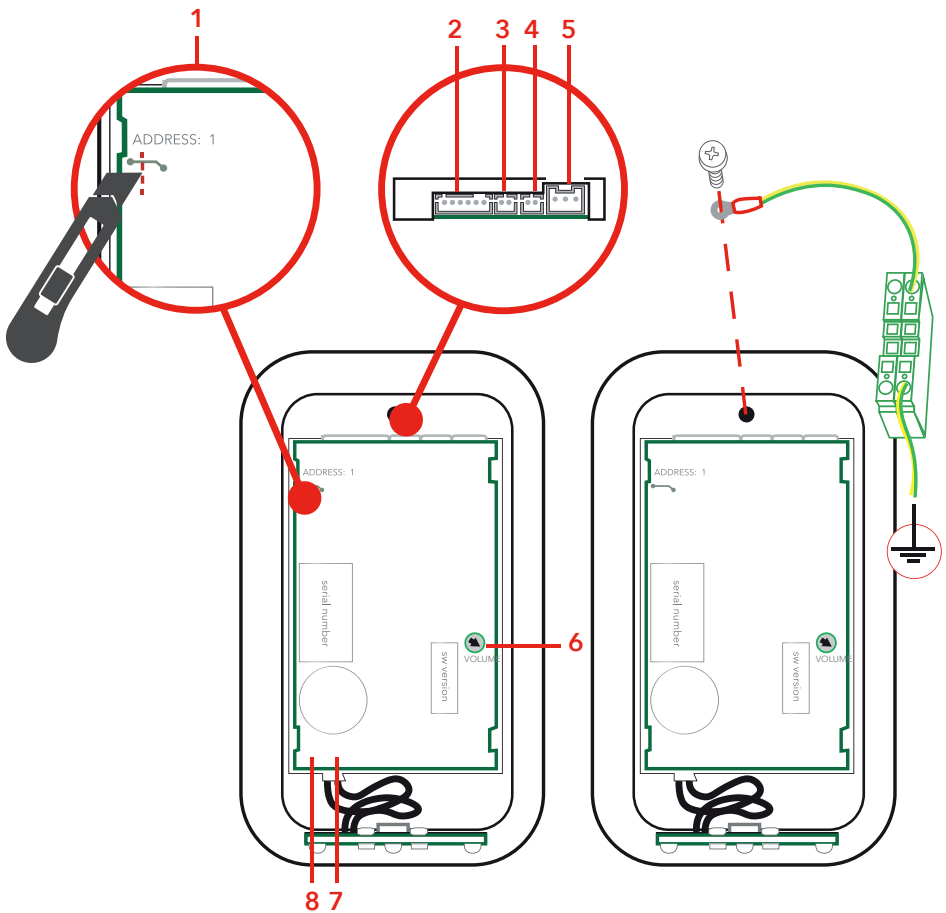

SL6-4G-UE

Evacuation unit

The voice stations can be connected to be used as an evacuation unit.

The evacuation unit can include up to 6 voice stations.

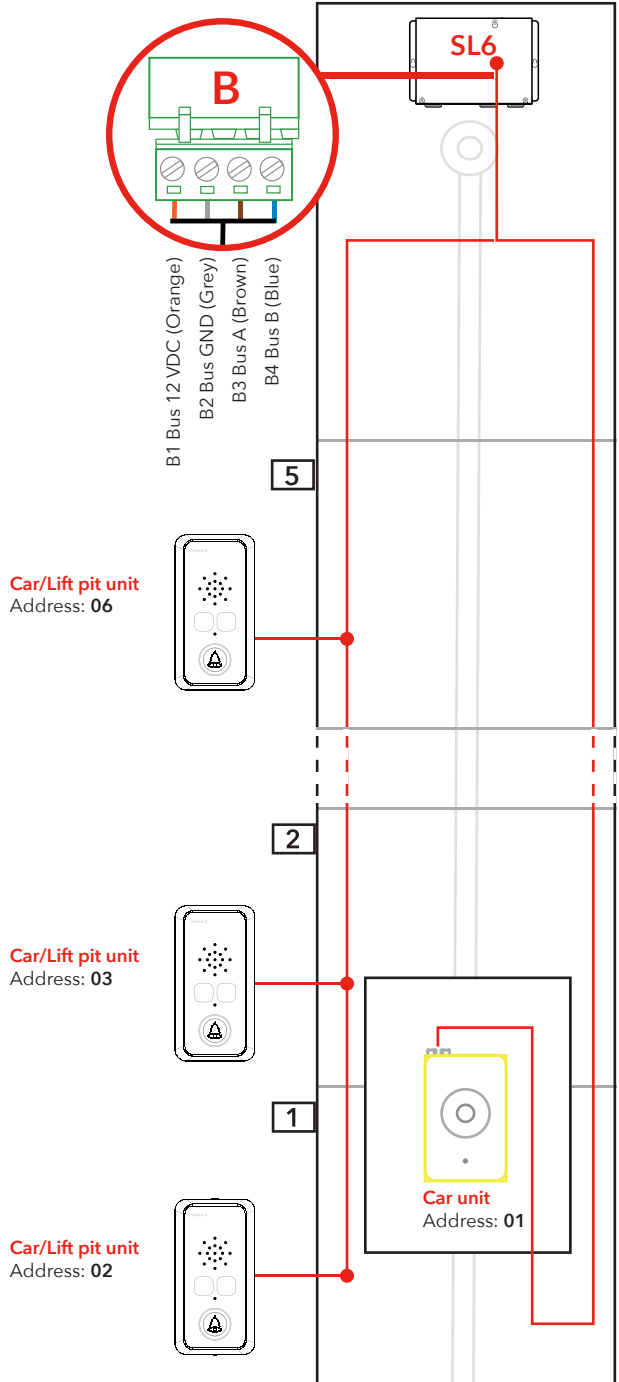

Installation

Mounting

If GSM interface is installed it has priority. If no active SIM card is used, GSM interface should be disabled.

Mounting main unit

Install the main unit in the machine room. Mount the SL6+ main unit to a stable surface (eg. wall, controller cabinet), using appropriate screws. No termination resistance is needed at the ends of the bus.

To avoid GSM interference: place the main unit, the stations and the GSM antenna at least 1,5 meters apart. The antenna must be placed on a metallic (earthed) surface of at least 150x150 mm and be placed standing (vertical).

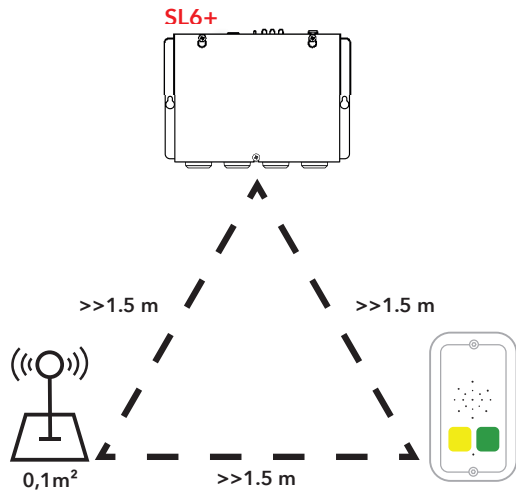

Mounting

If GSM interface is installed it has priority. If no active SIM card is used, GSM interface should be disabled.

Mounting additional circuit board

Unplug the main power and battery before performing any changes. Circuit boards that can be mounted are *SL6-GSM-BOARD or *IF-BOARD-4G (please refer to "Technical data" for detailed information).

***SL6-GSM-BOARD**
with Micro SIM Card

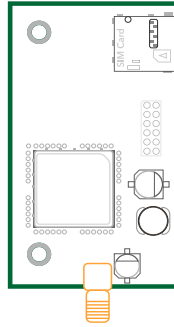

***IF-BOARD-4G**
with Micro SIM Card

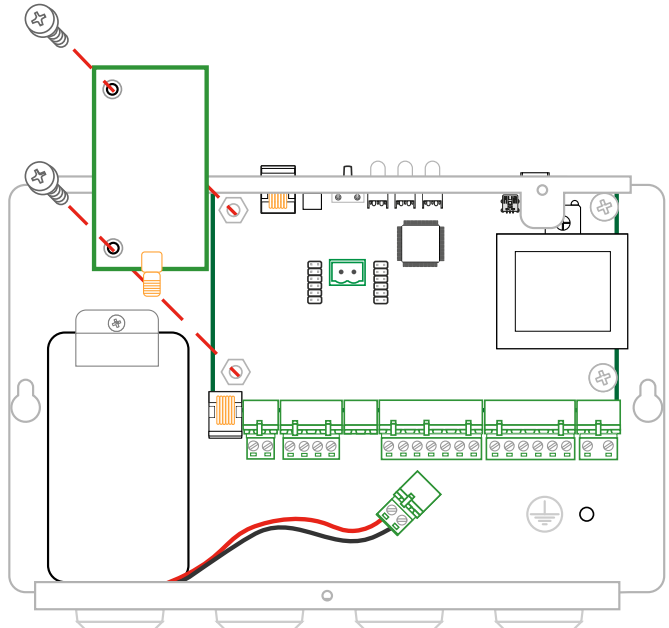
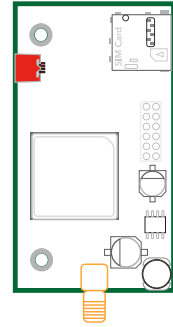

Wiring diagram SL6+ main unit

Supply voltage for the SL6 must go through an all-pole main switch in accordance with EN81-20.

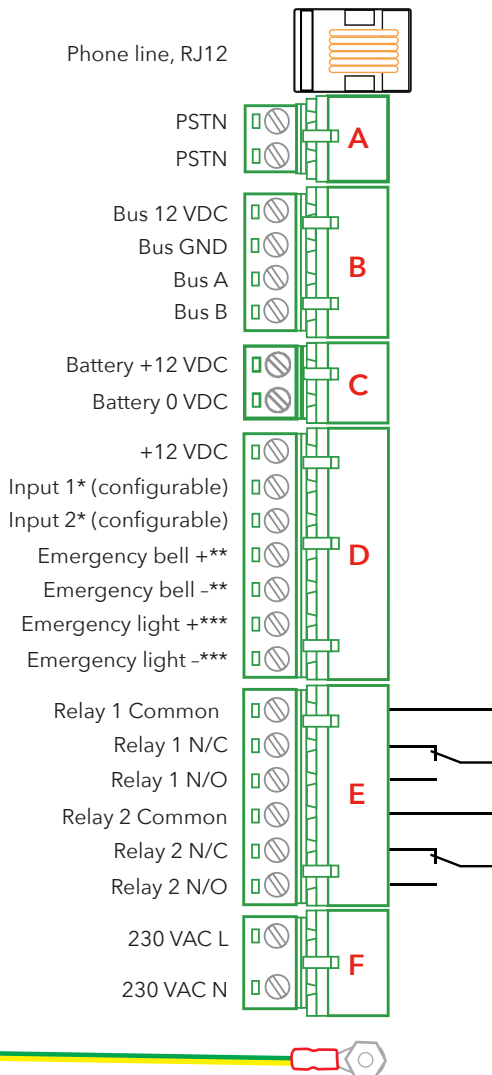
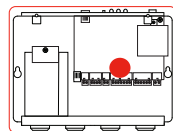

Input 1 and 2 options

None

Filter

LMS/SMS

Clear/Maintenance

Fire Mode (default input 2)

Alarm Button (default input 1)

Connect the protective earth connection to the enclosure, with a cable of at least 1,5mm².

* Input 1 and 2 are configurable N/O or N/C inputs with SafeLine Pro or SafeLine LYNX. For configuration details, see label to the left.

** Maximum 200 mA on the emergency bell output.

*** Maximum 500 mA on the emergency light output.

Wiring diagram voice station

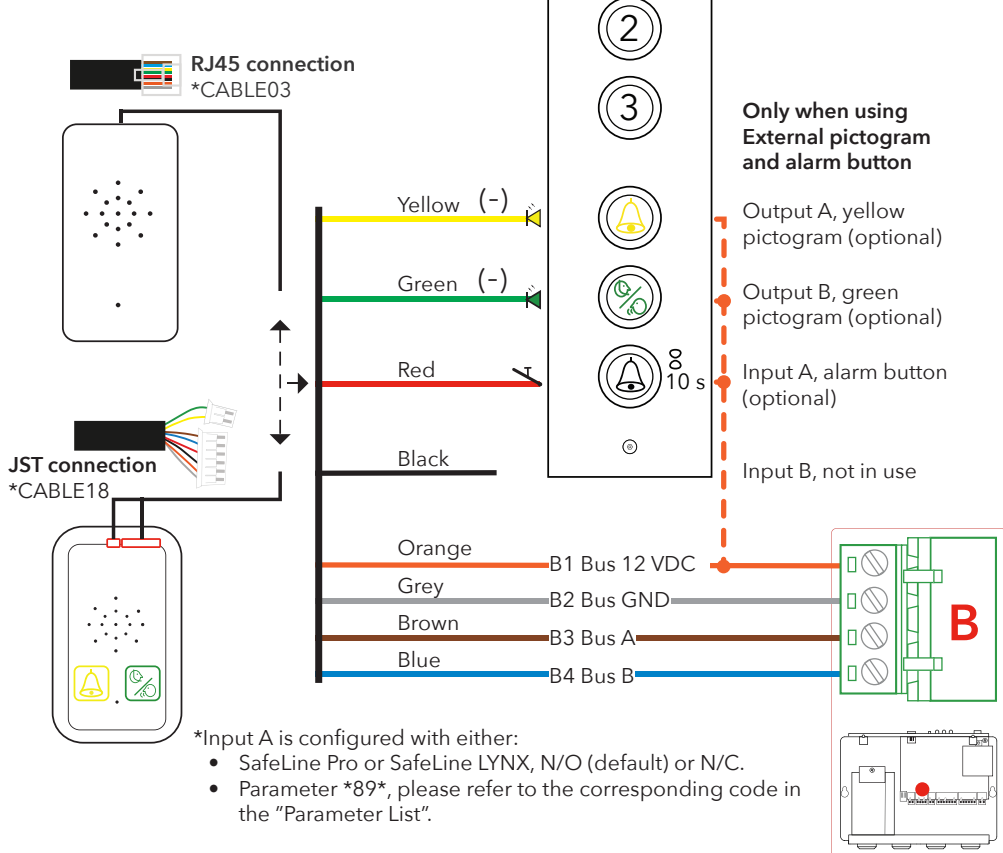

Wiring diagram voice station screw terminals

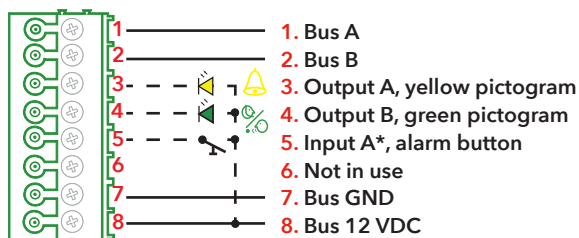

*Input A is configured with either:

- SafeLine Pro N/O (default) or N/C.
- Parameter *89*, please refer to the corresponding code in the "Parameter List".

Connecting the telephone line

Connect the telephone line parallel in universal terminals or the RJ-plug, see picture above. It's possible to connect up to nine SL6+ main units to the same telephone line.

In order to access the unit remotely, it needs to be assigned a unit number. Please refer to parameter *82* in the "Parameter List" for more information.

Phone line is connected via RJ12 or terminal A through the following:

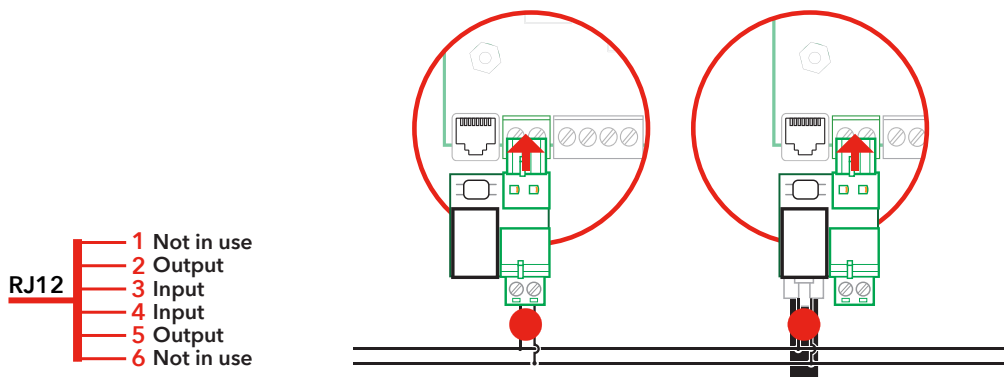

NOTE: a common mode choke is required (2.2 mH) if you have an SafeLine SL6+ with a PCB version below 1.51. You can identify the PCB version on your SL6+ by checking the main board's 7-figure number, e.g. "0175146", where the last three numbers indicates the PCB version. If you have an SL6+ with a version number above 1.50, you may disregard this information.

Activating the SIM card

If you enter the wrong PIN code 3 times, the SIM card will be blocked, requiring PUK code to unblock. If so, the SL6+ can not be started and LED3 will turn red.

The SL6+ can only recognize the PIN code if the code is set to "1234", "0000", "1111" or if it is deactivated. If set to anything else, the SL6+ can not use the SIM card.

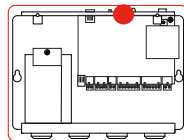

If the PIN code is set to "1234", "0000" or deactivated, the SIM card can be used on any of SafeLine's GSM products.

Setting the PIN code

1. Insert the SIM card in an ordinary cell phone. In the phone's security settings, change the PIN to "1234". If not possible, set the PIN code to "0000" or, if available, set the "PIN code request" option to "OFF".
2. Verify the PIN code by switching your phone off and on again.
3. Make a call from your phone to verify that the SIM card is active.
4. Make a call to the SL6+ after insertion to ensure there is a proper connection.

"1111" PIN code

If the PIN is set to "1111", the code will be randomly generated by the SafeLine GSM unit and memorized. This is a safety measure, making sure the SIM card will only work with the selected SafeLine GSM unit. To change the PIN again, use the PUK code provided to you by your mobile services provider for setting up a new PIN.

If you want to upload a new SIM card for the GSM unit with a new "1111" PIN, you will first need to upload a SIM card with PIN code "1234" or "0000" to clear the old code in memory.

Bluetooth LED indication

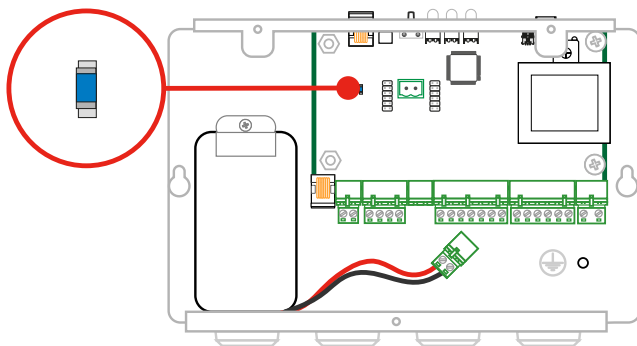

Bluetooth LED

Flashing blue

Slowly flashing blue

Flickering blue

Advertising, the unit can be found by the LYNX scanner.

Initiating, takes about one second.

Connected, the unit is connected to a cellphone.

LED indication front panel

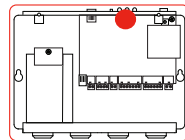

LED 1 indicates the power supply status

Continuous green	Mains power supply OK
Flashing red (400/400 ms)	Battery operated, with power to the emergency light.
Continuous red	Battery operated, no power to the emergency light

LED 2 indicates active alarm and battery condition

Light off	No active alarm/battery OK.
Rapidly flashing yellow (200/200 ms)	Active alarm not reset
Flashing red (400/400 ms)	Battery check in progress.
Continuous red	Battery test failure/no battery connected

LED 3 indicates the phone line's status

Flashing green (100/100 ms)	Fire mode activated.
Flashing green (400/400 ms)	Call connection in progress.
Slowly flashing green (200/4600 ms)	Telephone line connected. GSM network OK.
Continuous green	Call connected.
Flashing yellow (100/100 ms)	Incoming call.
Flashing red (400/400 ms)	PSTN: No telephone line connected. GSM: Searching for GSM network.
Continuous red	No SIM card (when using GSM).

Reset button

Press for 3 sec	Show GSM signal strength (see table below).
Press 3 times	Start a self test (battery + bus initialization).
Press once	Resets an active alarm. Aborts calls in progress.
Press 5 sec - release	SL6+ turns off. NOTE! Refers to battery powered only!

LED 1	LED 2	LED 3	GSM signal strength
			= 100 %
			>= 85 %
			>= 70 %
			>= 55 %
			>= 30 %*
			>= 15 %
			>= 0 %

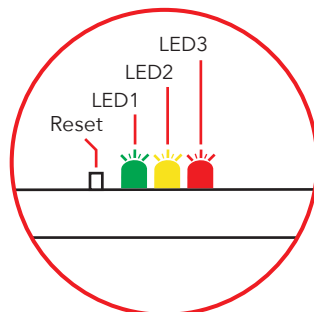

*Minimum signal strength for using GSM interface.

LED indication for pictogram in car

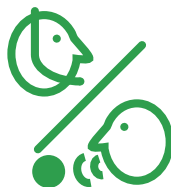
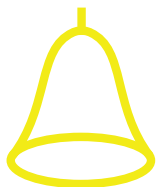
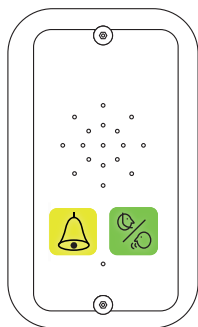

Yellow LED

Call in progress

The yellow pictogram LED is lit as soon as the alarm button is pressed.

Green LED

Call connected

The green pictogram LED turns on as soon as the SafeLine unit detects a responding voice.

The LED is turned off when the call is terminated.

Standard (*78*0#)

Light off

Yellow LED

No alarm activated

Green LED

Telephone line not OK.

Flashing slowly

Flashing once every 5 seconds

Telephone line not OK.

Flashing once every 5 seconds

Unit is OK.

Flashing quickly

Flashing twice every second

Alarm button active.

Flashing two times every 5 seconds

Alarm filter activated.

Continuous light

Activated alarm. Remains lit until reset.

Call connected.

Strictly EN81-28 (*78*1#)

Flashing

Flashing twice every second

Alarm button active.

Continuous light

Activated alarm. Remains lit until reset.

Call connected.

Test alarm failure

Yellow LED

Light on for 1 second then light off for 1 second

Test alarm (line check) failed

Returns to normal at next valid test alarm.

Green LED

Test alarm (line check) failed

Returns to normal at next valid test alarm.

Startup

Startup procedure

The unit will not start at battery connection only.

1. Upon startup: a tone sequence is heard in the system speaker.
2. Check 230 VAC mains power.
3. SL6+ main unit searches for stations connected to the bus. For every voice station found, a beep sound is heard in the system speaker.



Example: found all voice stations except for number

4. Refer to chapter: Troubleshooting voice station.
5. When a working telephone line is connected or a GSM net is available, LED 3 is flashing green every 5 seconds.
6. Refer to chapter: Troubleshooting main unit.

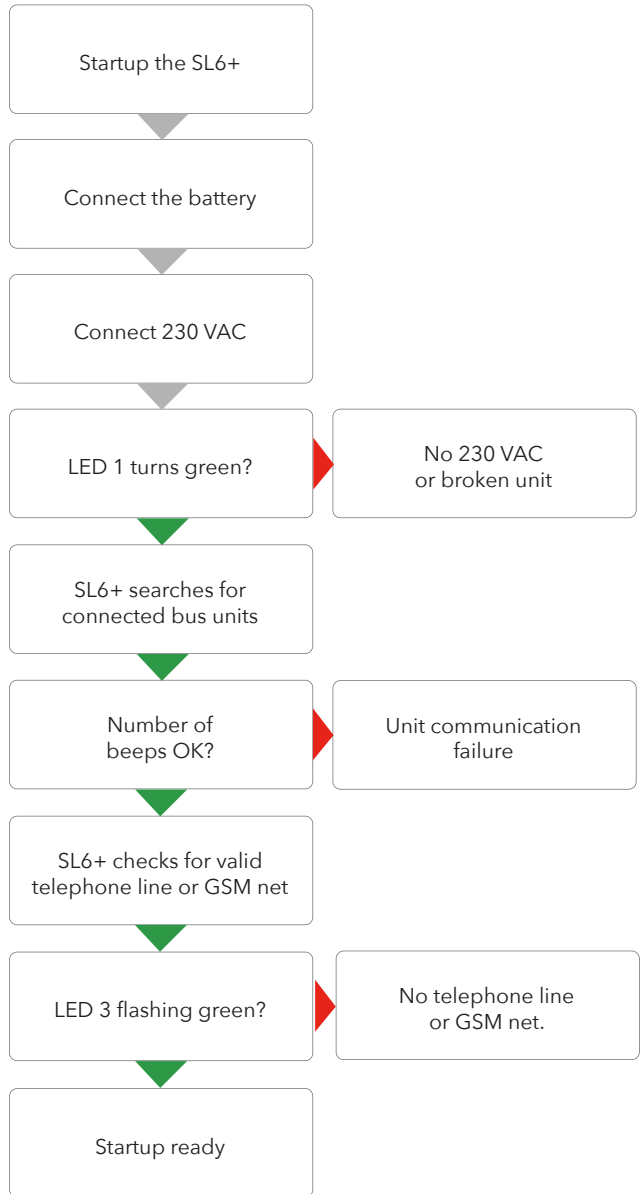

Configuration

Configuration overviews

Configuration methods and configuration codes with a telephone is described on the following pages under "Remote configuration with telephone" and "On-site configuration with telephone".

Configuration with SafeLine Pro

The unit can be configured at the office prior to the installation or on site after installation.

The configuration software SafeLine Pro can be downloaded from www.safeline-group.com.

The configuration cable is provided by SafeLine.

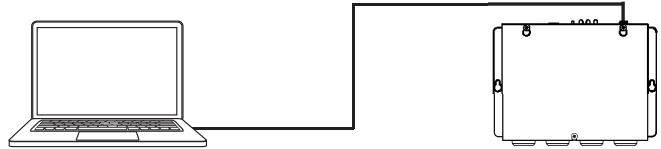

Remote configuration with SafeLine Pro/ProLink

The unit can also be remotely configured at the office after installation. Connect a SafeLine ProLink modem with a phone line to a computer with SafeLine Pro and a serial cable.

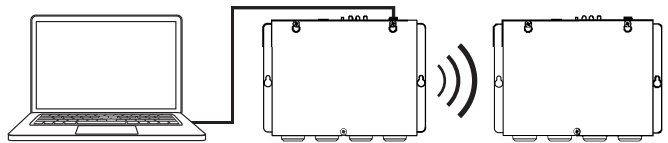

Configuration with the LYNX app

For configuration via app, download the LYNX app from Google Play or Apple App store and register an account.

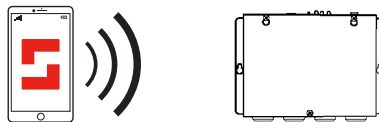

Configuration overviews

On-site configuration with telephone

For configuration, you can use any PSTN tone dial phone.

- Plug the handset into the RJ12 contact of the main station
- (see "Screw terminal for optional telephone handset").
- Enter configuration codes on the handset keypad.

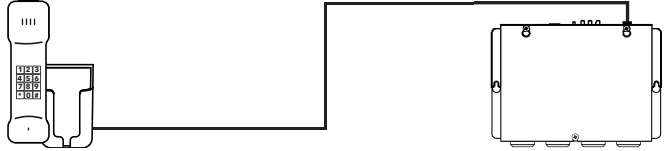

Remote configuration with telephone

For remote configuration, you can use any PSTN tone dial phone.

- Dial the phone number of the SL6+.
- Enter the function codes on the phone keypad to start configuration (password has to be entered, see "Parameter list").

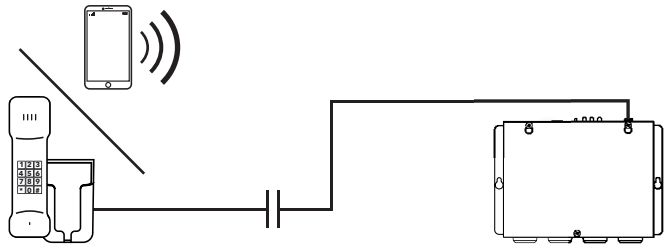

Remote configuration with telephone/calling the SL6: step 1

In order to remotely configure or call a unit in the SL6+ system, the unit must first be put into configuration mode via voice communication mode.

Follow the steps below to enter voice communication mode.

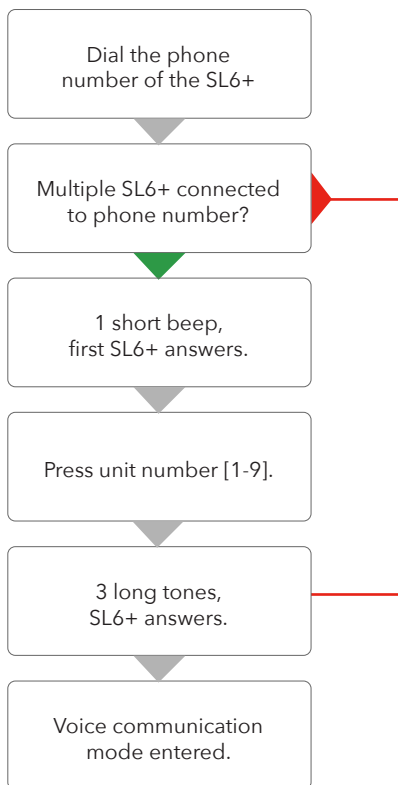

1. Dial the phone number of the unit.
2. If there is only one unit in the system, proceed to step 5. If there are multiple units connected in parallel, proceed to step 3.
3. After 2 rings the first SL6+ unit answers with a short beep.
4. Choose which unit to configure by pressing the unit's number.
NOTE: If there are other SafeLine telephones connected in serial you may have to press the unit number several times before the 3 long tones are heard.
5. When 3 long tones are heard, the selected unit is reached and voice communication mode is established.
NOTE: the telephone will now beep every 5 seconds to notify the passengers of the ongoing call (anti eavesdropping).

Remote configuration with telephone: step 2

If the time between the operation of two keys exceeds 10 seconds, the code has to be re-entered. If the time between exceeds 30 seconds, the call is disconnected or configuration mode is ended.

After having entered voice communication mode, use the parameter codes found in the "Parameter List" to remotely configure the SafeLine SL6+.

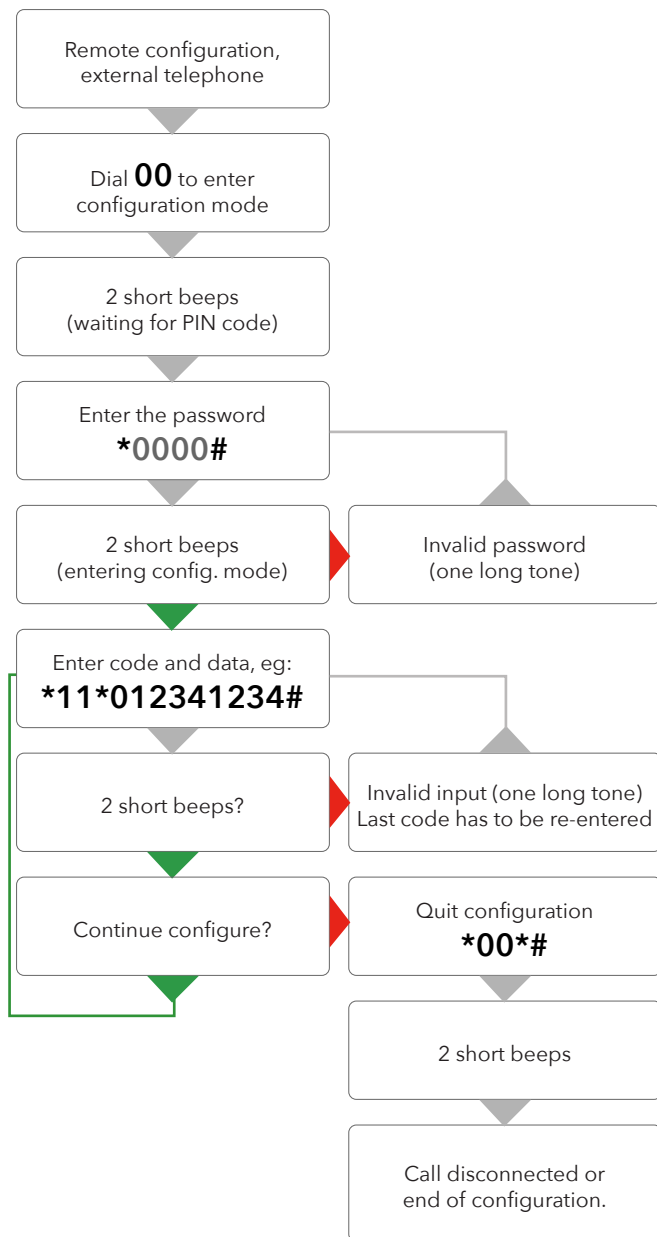

Initiate a restart from remote

In order to remotely force the SL6 main unit to restart please follow these steps:

- Follow the steps of "Remote configuration with telephone: step 1"
- Dial **01** to enter
- Enter the password ***0000#**
- Enter the code ***37*#**
- The SL6 unit will now restart.

For more information about Parameter *37*, please refer to the corresponding code in the "Parameter List".

On-site configuration with telephone

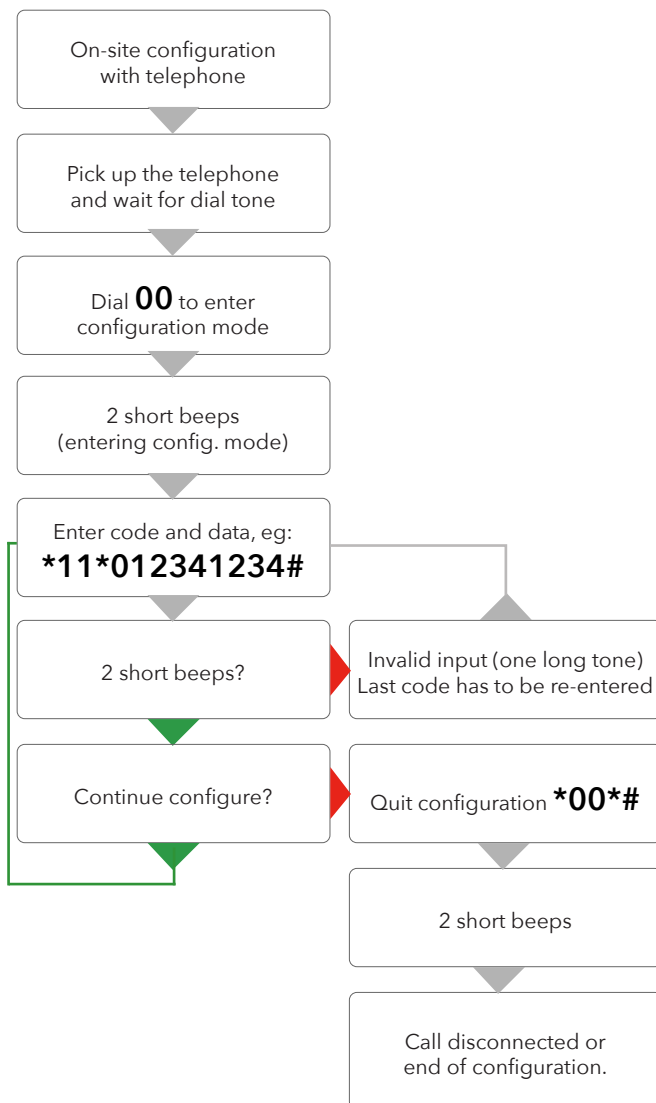

Configuration examples

If at any time you need to start over, use the factory reset command *99*1#. Please refer to the full configuration setup in the "Parameter list" as these are merely examples.

SafeLine emergency telephone units

Example 1.

Storing of two different telephone numbers, one to be answered by P100 code and the other one with voice. (For test facility, see example 2.)

1. Start configuration:

0 0

2. 1st phone number:

*** 1 1 * 1 2 3 4 5 6 7 8 #**

3. 2nd phone number:

*** 1 2 * 2 3 4 5 6 7 8 9 #**

4. Call type 1st number:

*** 2 1 * 0 #** - Example: Answered with P100 code.

5. Call type 2st number:

*** 2 2 * 1 #** - Example: Answered as voice call.

6. Alarm button delay:

*** 8 7 * 0 3 #** - Example: 3 seconds delay.

7. End configuration:

*** 0 0 ***

Example 2.

SLCC (SafeLine Call Centre) and 3 day test.

1. Start configuration:

0 0

2. Enter P100 ID code:

*** 0 1 * 4 5 6 4 5 6 4 5 #**

Lift ID code (each lift must have its own unique code).

3. Set test alarm type:

*** 3 1 * 0 #** - Example: Test alarm type P100.

4. Set number of days between test alarm:

*** 2 7 * 0 3 #** - Example: 3 days between test alarm.

5. LMS phone number:

*** 1 6 * 9 8 7 6 5 4 3 2 #**

(Only if using SLCC)

6. Test alarm:

*** 1 7 * 1 2 3 1 2 3 1 2 #**

(For more information, please refer to parameter *17* in the "Parameter list")

7. End configuration:

*** 0 0 * #**

Parameter list

Configuration data	Code	Data	Comments
Enter configuration mode		00	
Enter password		* - - - #	Default = 0000
Exit configuration mode		*00*#	
Remote restart	Code	Data	Comments
Enter configuration mode		01	From v 4.80
Enter password		* - - - #	Default = 0000
Restart device		*37*#	
Exit configuration mode		*00*#	
Alarm codes	Code	Data	Comments
P100 ID code	*01*	- - - - - #	P100 is always 8 digits
CPC ID code	*02*	- - - - - #	CPC 6-8 digits
Q23 ID code	*03*	- - - - - - - #	Q23 is always 12 digits
Telephone numbers	Code	Data	Comments
1st Phone number	*11*	- - - - - - - #	Phone number to alarm receiver: 1-20 digits.
2nd Phone number	*12*	- - - - - - - #	If calling through a switchboard, delay time can be set by adding asterisks (*) between leading number of the switchboard and telephone number for the alarm call receiver. Each asterisk (*) is equal to one second delay.
3rd Phone number	*13*	- - - - - - - #	
4th Phone number	*14*	- - - - - - - #	
			Example #1: *11*0**1234567#
			Example #2: *11*# deletes the phone no.
Call type	Code	Data	Comments
Call type 1st number	*21*	- #	Change the call type of the stored telephone numbers: 0 = P100 1 = VOICE (default) 2 = Q23 3 = CPC
Call type 2nd number	*22*	- #	
Call type 3rd number	*23*	- #	
Call type 4th number	*24*	- #	
			Change this only if your alarm operator uses any of the mentioned protocols.
Call type LMS number	*30*	- #	LMS (Lift Monitoring System) call type 0 = P100 3 = CPC (Only battery alarm) 5 = SMS

Test alarm & battery alarm	Code	Data	Comments
LMS phone number	*16*	-----#	LMS (Lift Monitoring System) phone number to alarm receiver or SLCC.
Test alarm	*17*	-----#	Phone number to send testalarm to alarm receiver or SLCC.
Call back test alarm	*19*	-----#	Triggers a test alarm event to a user selected phone number. The call is made after the configuration is terminated.
Days between tests	*27*	--#	Number of days between test alarms, 00-99 days. Always two digits. Max 3 days according to EN 81-28. 00 = No test alarms
Test alarm protocol	*31*	-#	0 = P100 3 = CPC 4 = Caller ID
Alarm type	Code	Data	Comments
Alarm type 1st number	*41*	--#	Only when using CPC as alarm protocol Normally 10 or 27, check with your alarm company!
Alarm type 2nd number	*42*	--#	
Alarm type 3rd number	*43*	--#	
Alarm type 4th number	*44*	--#	
Alarm type LMS	*45*	--#	LMS (Lift Monitoring System) (Battery alarm) Normally 17
Alarm type Test alarm	*46*	--#	Normally 26

Distress message	Code	Data	Comments
Record distress message played in the lift car.	*50*	"Speak" #	This message will be played in the lift car when the emergency lift telephone starts calling the alarm centre, so make sure it's quiet when recording the message. Example of message: "Please do not panic, the emergency telephone is now calling the emergency call centre."
Record alarm message from bus unit 1 to alarm central	*51*	"Speak" #	This message will be played to the alarm receiver and in the car when the call is answered. Make sure that there is no noise in the background when recording the message.
Record alarm message from bus unit 2 to alarm central	*52*	"Speak" #	
Record alarm message from bus unit 3 to alarm central	*53*	"Speak" #	Example of message: This is an alarm from the lift on 5th avenue.
Record alarm message from bus unit 4 to alarm central	*54*	"Speak" #	To hear the message again, and listen to the quality of the message, press "1". To terminate the call press "#".
Record alarm message from bus unit 5 to alarm central	*55*	"Speak" #	To play the recorded message, press the desired parameter followed by #.
Record alarm message from bus unit 6 to alarm central	*56*	"Speak" #	For example: *61*# in order to play the message from the bus unit.
Record fire message	*57*	"Speak" #	0 = Disable recorded message. 1 = Enables recorded message.
Options for the recorded distress message	*60*	- #	
	60	#	
Options for the recorded message from bus unit 1	*61*	- #	
	61	#	
Options for the recorded message from bus unit 2	*62*	- #	
	62	#	
Options for the recorded message from bus unit 3	*63*	- #	
	63	#	
Options for the recorded message from bus unit 4	*64*	- #	
	64	#	
Options for the recorded message from bus unit 5	*65*	- #	
	65	#	
Options for the recorded message from bus unit 6	*66*	- #	
	66	#	
Options for the recorded fire message	*67*	- #	
	67	#	

Other codes	Code	Data	Comments
2G/3G/4G	*07*	-#	Selects which network combination to be available when * IF-BOARD-4G is installed 0 = 2G + 3G + 4G (default) 1 = 2G + 3G 2 = 2G + 4G 3 = 3G + 4G 4 = 2G 5 = 3G 6 = 4G
Modem functions	*09*	-#	0 = USB 1 = Series (RS232)
Repeated alarm	*39*	-#	Repeated alarms: Battery failure, Mic/Speaker failure, Stuck button. Alarm action repeats every 24h until the problem is resolved. 0 = Off (default) 1 = On
Buzzer	*71*	-#	The buzzer will sound at incoming call or at intercom use. 0 = Off 1 = On (default)
Ring-tone timeout	*72*	--#	Number of ring signals before dialling the next number (default = 08).
External inputs - Function	*73*	--#	The first number selects the input, i.e. Input 1 or Input 2. The second number selects the function. 0 = None 1 = Filter 2 = Clear/Maintenance 3 = Fire Mode 4 = Alarm Button (default = input 1) 5 = Call Delay Example: *73*11# - Input 1, Filter *73*26# - Input 2, Call Delay
External inputs - Input N/O or N/C	*74*	--#	The first number selects the input, i.e. Input 1 or Input 2. The second number selects N/O (0) or N/C (1). Default = N/O Example: *74*11# - Input 1, N/C *74*20# - Input 2, N/O
Hotline	*75*	-#	Phone connects directly to a fixed recipient without phone number. 0 = Standard phone line (default) 1 = Hotline

Other codes	Code	Data	Comments
Compatibility mode	*77*	- #	<p>0 = Automatic voice switching (default) The call is validated when there is a voice response. The call is terminated by pressing “#”.</p> <p>1 = Kone ECII (lift telephone) When there is a voice response, some ascending tones will be heard. The call is validated by pressing “4”. The call is terminated by pressing “0”. The call is terminated without receipt notification by pressing “2”(the unit will call the next number).</p> <p>2 = Manual voice switching When there is a voice response, some ascending tones will be heard. The call is validated by pressing “4”. Unit is still in automatic mode. To enter manual mode and talk press “*”. To listen press “7”. Go back to automatic mode press “4”. The call is terminated by pressing “#”. It is possible to enter manual voice switching mode although the unit is programmed as automatic by pressing “*”. No ascending tones will be heard. For repeating the Alarm messages to operator, press “1” in all in/out going calls.</p> <p>3 = Swiss Mode (Alarm operator mode) Only to be used in voice mode. Disconnect by “0”. Dials the next number if call timeout, blocking tone, new dialing tone, and operator silence.</p>
Indicator mode	*78*	- #	<p>0 = Standard (default) 1 = Strictly EN81-28</p>
Maximum communication time. Incoming/outgoing calls	*79*	- #	<p>1 - 5 minutes. (Default: VOICE = 5 min, other protocols = 8 min)</p>
Reset active alarm	*80*	- #	<p>0 = Off 1 = On (default)</p>
Auto answer	*81*	-- #	<p>Number of signals before SafeLine answers incoming call. Can be set from 00-16 (default = 02). 00 = Never answering.</p>
Unit number	*82*	- #	<p>Unit number [0] is set by default, and means that the unit will respond immediately. Unit number [1-9] is used when the units are sharing the same phone line. When the unit number is assigned, the specified unit is accessible for configuration.</p>
Detect dial tone	*83*	- #	<p>0 = Off 1 = On (default) Set to off if SafeLine has problem to detect the dial tone.</p>

Other codes	Code	Data	Comments
Receipt to alarm receiver	*84*	- #	Select which message(s) to send to the alarm receiver at an alarm call. 0 = None (default) 1 = Start of alarm 2 = Start+end of alarm
Break on new alarm	*86*	- #	Disconnects a call longer than 60 sec. at new activation of the alarm button and calls the next emergency call number. 0 = Off 1 = On (default)
Alarm button delay time	*87*	-- #	Delay time from pressing the alarm button until activating the alarm. 00-25 seconds. Default = 05
Outputs (Relay)	*88*	-- #	The first number selects the relay output, i.e. Relay 1 or Relay 2. The second number selects the function. For SW 4.00 or later, the following parameters are used: 0 = Alarm status outputs (default relay 1) 1 = Battery failure (default relay 2) 2 = Pictogram (Relay 1: yellow, relay 2: green) 3 = Activate with DTMF 8/9 (Relay 1 - DTMF 8, relay 2 - DTMF 9) 4 = Manual reset 5 = Emergency call failure 6 = System failure 7 = Emergency bell Example: *88*11# - Relay 1, battery failure *88*26# - Relay 2, system failure For more information, please refer to "Relay functions". For SW previous to 4.00, the following parameters are used: 0 = Standard (default) 1 = EN81-28 Pictograms 2 = DTMF-controlled 3 = Manual - ECF (Emergency Call Fail) For more information about the parameters in the older versions, please contact the support team.
Bus unit	*89*	-- #	Selected alarm input type for the bus unit (N/O or N/C). First number selects the bus unit (1-6). Second unit selects N/O (0) or N/C (1). Example: *89*21# sets bus unit 2 as N/C

Other codes	Code	Data	Comments
Voice station - Integrated emergency bell	*90*	-- #	Local configuration of emergency bell voice station. First number selects voice station (1-6). Second number selects Off (0 = default) or On (1). Example: *90*21# sets voice station 2 to On
Pwd for remote configuration	*91*	--- #	Change password (default=0000).
Operator silence disconnect	*92*	- #	Disconnects the call when the alarm operator has been quiet for longer than the time set. 0 = Off (default) 1 = 30 sec 2 = 60 sec 3 = 90 sec
Fallback	*93*	- #	0 = Disabled (default) 1 = Priority PSTN 2 = Priority GSM
Simulate an alarm event	*94*	- #	Triggers an alarm event after configuration is terminated. 1 = Emergency call 2 = Test alarm 3 = Battery failure 4 = Microphone/speaker failure 5 = Receipt on voice call 6 = Maintenance 7 = Main unit power failure 8 = Stuck button alarm
GSM/PSTN - RX audio level	*96*	- #	Increases the received audio level. Is used only if the audio level from the alarm central is to low. 0 = 0% (default) 1 = +25% 2 = +50% 3 = +75% 4 = +100% NOTE: SW 4.4 0 or later is required. For PSTN, HW 1.41 or later is required.
Background level compensation	*97*	- #	0 = Off (default) 1 = On
Reset to default settings	*99*	- #	1 = Factory standard 2 = Default P100 (The following codes will be set): *21*0#, *22*0#, *27*03#, *80*1#, *84*1#, *88*12# 3 = Default CPC (The following codes will be set): *21*3#, *22*3#, *27*03#, *80*1#, *84*1#, *88*12# 4 = Default VOICE (The following codes will be set): *21*1#, *22*1#, *27*03#, *80*1# *84*1#, *88*12#

Relay functions

This applies for SW 4.00 or later. (For functions of earlier versions, please contact the Support team.) Relays 1 and 2 can be programmed independently.

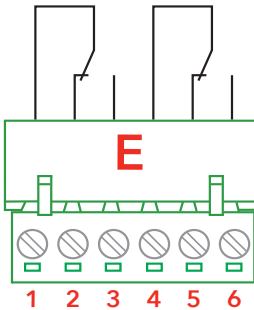
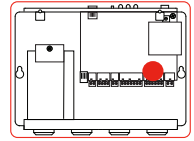

Alarm status outputs

- Relay will be activated when set time is reached.
- Relay will be deactivated when emergency call ends.

Battery failure

- Relay will be activated when the battery test has failed.
- Relay will be deactivated by pressing the reset button.

Pictogram yellow (only relay 1)

- Relay will be activated when the alarm button is pressed (yellow pictogram).
- Relay will be deactivated when the reset button is pressed or if alarm centre presses "5".

Pictogram green (only relay 2)

- Relay will be activated when the call is acknowledged (green pictogram).
- Relay will be deactivated when the call is disconnected.

Activate with DTMF 8 (only relay 1)

- Relay will be activated for 5 seconds when DTMF "8" is pressed.

Activate with DTMF 9 (only relay 2)

- Relay will be activated for 5 seconds when DTMF "9" is pressed.

Manual reset

- Relay will be activated when set time reached.

Emergency call failure

- Relay will be activated when the emergency call failed after 12 attempts, "Emergency Call Fail".

System failure

- Relay will be activated when power (230 VAC) and PSTN/GSM net is OK.
- Relay will be deactivated when power supply is gone more than 15 min or when there is no GSM- or PSTN-net.

Emergency bell

- Relay will be activated when the emergency bell input is active.
- Relay will be deactivated when the emergency bell input is deactivated.

Call retry failure

- Relay is activated when current relay is in Standby Mode.
- Relay is deactivated if failing to deliver an alarm. If fallback is active, both interfaces have failed. Relay closes at successful deliverance.

Automatic emergency button check

- Relay is active once every day, checking emergency button.
- Relay is deactivated when emergency button input is changed, or if collective fault is programmed on an output.

Collective fault

Activate* this relay function in the SafeLine LYNX app or SafeLine Pro.

A relay function combining different relay functions in one. When function is active it is affected by 4 failures:

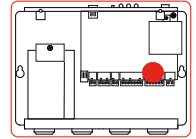

1. System failure

- Activates the relay when main power is ok and one interface is available (PSTN has detected the line or GSM is online).
- Deactivates when main power is not ok or no interface is available.

2. Battery failure

- Deactivates in case of failed battery test
- Resets by pressing the "Reset Button"

3. Automatic emergency button check fault

- Relay activates once every day. If something is wrong with button, an alarm is sent to the alarm receiver.
- If collective fault is programmed on an output, this is released.
- Resets when emergency button input is changed.

4. Call retry failure

- Deactivates if the unit after programmed number of tries fails with alarm drop-off (if Fallback is activated both interfaces have failed).
- Resets in case of successful alarm delivery
- Resets by pressing the "Reset Button"

* SMS programming only available for SL6-GSMR and SL6-MINI-GSMR.

Calling with SafeLine SL6+

Installing the handset and the SL6+ in the machine room is recommended.

The handset can not be called from the car unit.

The SL6+ can call in the following ways:

1. Intercom between machine room and car/pit/car-top, see below.
2. Make calls with a normal fixed phone line and through GSM.
3. Emergency calls to numbers at the press of the alarm button.
4. Test alarms at preset intervals.
5. Send receipts to SLCC alarm receiver for defined conditions.
6. Send SMS to one or several GSM phones at defined conditions (GSM only).
7. Provoke test calls.

Intercom between machine room and car/pit/car-top.

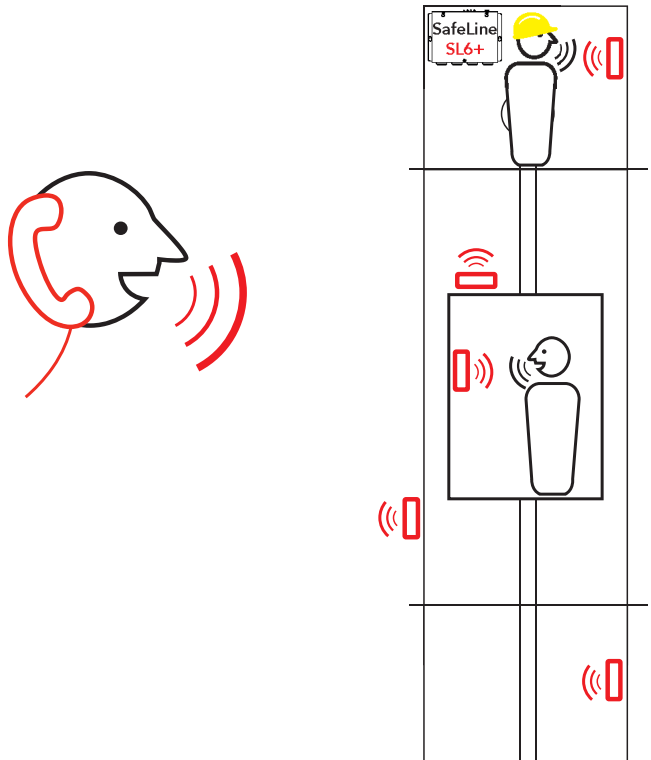

Intercom between main unit and voice station

Main station to voice station:

Press 1-6 on the handset to call respective voice station.

Voice station to main station:

Press the button on the voice station briefly to call the main station.
(Hold the button for 5 seconds to make an emergency call.)

Outgoing call

Press 0 to dial external telephone number. If the Safeline SL6+ is connected to a PABX (switchboard), press 0 again for external dial tone to calling out to the PSTN network. If a GSM board is installed, the SL6+ will use it as the default. If you want to use PSTN line instead, ensure that there is no GSM board installed.

Turn off outgoing calls through the configurational handset using the SafeLine LYNX app:

Configuration -> Calls -> Config-handset test call

Emergency calling process

With 4 stored telephone numbers in the system, each number can be called 3 times. This adds up to the 12 call limit.

Push the alarm button in the lift cabin to initiate an emergency call. To restart the dialling process, push the alarm button again.

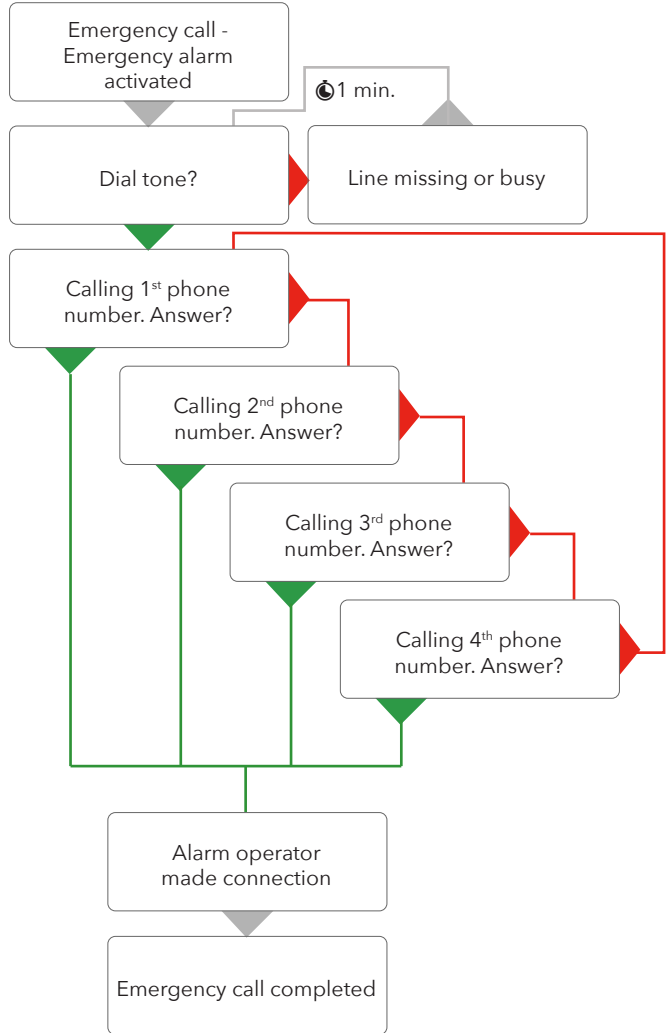

Fallback

For programming, use SafeLine Pro, SafeLine LYNX or parameter *93* (please refer to the corresponding code in the "Parameter List").

If no active SIM card is installed, GSM interface should be disabled.

The Fallback function gives access to use both the PSTN and GSM for emergency calls. Set one as a priority and the other one works as fallback in case the prioritized one fails (the function requires that both phone line and GSM SIM card are active).

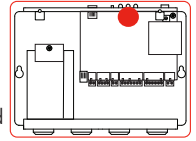

Enable Fallback through SafeLine LYNX or SafeLine Pro. When activating Fallback, both systems have to be operative. Incoming calls are handled by both interfaces, but will not be used simultaneously. The chosen interface is locked while in-/outgoing calls are ongoing.

NOTE: when Fallback is active, phone numbers' prefix is filtrated automatically (e.g. 0*0890510 becomes 0890510). This lets the same configured number be used for both PSTN and GSM.

Fallback

LED 3:

Fallback disabled - PSTN interface



Flashing Red, 400/400 ms: no line



Slowly flashing green, 200/4600 ms: line OK



Flashing green, 400/400 ms: connecting call



Continuous green: call connected

Fallback disabled - GSM interface



Continuous red:
GSM interface error (PIN, SIM, communication)



Flashing red, 400/400 ms: no GSM net



Slowly flashing green, 200/4600 ms: line OK



Flashing green, 400/400 ms: connecting call



Continuous green: call connected

Fallback enabled



Continuous red:
GSM interface error (PIN, SIM, communication)



Flashing red, 400/400 ms: Neither line nor GSM OK



Flashing red/green, 400/400 ms:
PSTN-line or GSM net missing



Slowly flashing green, 200/4600 ms: line OK



Flashing green, 400/400 ms: connecting call



Continuous green: call connected

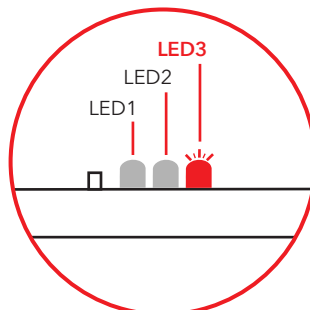

Fallback LMS codes

Fallback LMS codes:

Z001: PSTN: If mains power is out longer than set time (Fallback Alarm Delay), an LMS is sent with the code Z001

Z002: When power returns and has been back for more than set time, an LMS is sent with the code Z002.

Z003: GSM: If ASU levels are lower than limit value (5) for set time (Fallback Alarm Delay), an LMS is sent with the code Z003.

Z004: When ASU levels are higher than limit value (5) and has been for more than set time, an LMS is sent with the code Z004.

Z005: PSTN: If alarm drop-off fails through any of the interfaces (e.g. no response, busy line, no P100 start tone/acknowledgement) and Fallback is active, an LMS is sent with the code Z005.

Z006: PSTN: If alarm drop-off fails through the prioritized interface, the unit also tries the secondary interface. If drop-off fails through any of the interfaces (e.g. no response, busy line, no P100 start tone/acknowledgement) and Fallback is active, an LMS is sent with the code Z006.

Z007: GSM: If alarm drop-off fails through any of the interfaces (e.g. no response, busy line, no P100 start tone/acknowledgement) and Fallback is active, an LMS is sent with the code Z007.

Z008: GSM: If alarm drop-off fails through any of the interfaces (e.g. no response, busy line, no P100 start tone/acknowledgement) and Fallback is active, an LMS is sent with the code Z007.

Z009: If no dial tone is detected through outgoing PSTN call attempt, call attempts are cancelled through PSTN so the unit may try GSM immediately instead. If the call attempt is cancelled due to missing dial tone while Fallback is active, an LMS is sent with the code Z009.

Fire mode

The SL6+ system can be used as a firefighter intercom system. Depending on the configuration, you can have up to 6 voice stations as fire units. Start Fire Mode by activating input 2 (default) on the main unit. Refer to the "Wiring diagram SL6+ main unit".

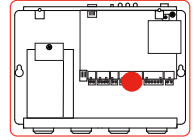

Configuration

Use SafeLine Pro, LYNX or parameter *73* (please refer to the corresponding code in the "Parameter List") to configure the units for Fire mode.

- Set Input 1 to Fire mode: *73*14#.
- Set Input 2 to Fire mode: *73*24# - default.
- Select other voice stations to be included in Fire mode with SL Pro.

Operation

Activating Fire mode does the following:

A siren sound is heard in the speaker of the main unit during the active time. Press the reset button to stop the siren sound. A voice message specifically for Fire mode is played. Refer to the "Distress message"-section of the "Parameter List" table. When Fire mode is activated the units operate as intercom units only and can not make emergency calls.

Voice communication

- Voice station in the car: microphone and speaker are both active.
- Other units: the alarm button has the "Push to talk/Release to listen"-function.
- A short beep is heard when you press/release the button.
- When in Fire mode, use the configuration handset to participate in an intercom conversation.
- The yellow pictogram lights up when Fire mode is activated.
- The green pictogram lights up when in speech mode and is out when listening.
- End Fire mode by disabling the input (1 or 2) on the main unit configured for Fire mode.

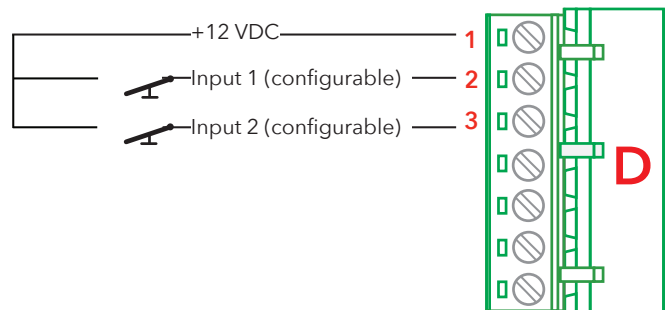

Battery function

The expected life of a lead battery is approximately 3 years, but several factors can affect the battery's life time, for example:

- Ambient temperature
- Humidity,
- Long-time storage of the battery before powering, etc.
- If the battery has been completely discharged for a longer period of time, it will never regain full capacity.

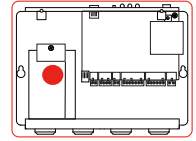

Battery status check

- An automatic battery status check is emitted every 7 days.
- If so configured, when the battery test fails, a battery alarm will be emitted to an alarm receiver.
- Reset the alarm by pressing the reset button.

Battery test

- If the reset button is pressed 3 times within 2 seconds, a battery test will be performed. The battery test takes about 20 minutes.
- If the battery is low, the test will be cancelled. When using the relay: LED 2 and the battery alarm relay will be activated. Relays can be activated for battery alarm by using parameter *88* (please refer to the corresponding code in the "Parameter List").

Cancelling a battery test

- Press the reset button once.
- LED 2 stops flashing red.
- If the battery level drops below 10,7 V, the SL6+ does not start automatically, it must be started by pressing the reset button.

Testing the battery alarm

- Unplug the battery contact during the battery status check.
- The SL6+ will now emit a battery alarm and LED 2 and battery alarm relay will be activated (if so configured).

Changing the battery

- Disconnect the 230 VAC voltage supply.
- Change the battery (article number *Batt 1,2 A).

Mains power failure

- The Mains power failure alarm is sent to the alarm receiver (SLCC) after 15 minutes of mains power failure.

Trouble-shooting main unit

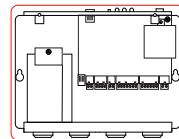

Problem	Possible cause(s)	Solution
The unit makes an alarm call when powered up.	<ul style="list-style-type: none"> • Improper type of alarm button selected. • Alarm button is stuck. 	Use SafeLine Pro or a telephone and parameter *74* and/or *89* to change from N/C (Normally closed) to N/O (Normally open) or from N/O to N/C.
The alarm start to sound directly at power-up.	<ul style="list-style-type: none"> • Output 2 is set to N/C. • Input 2 is set to N/O as default. 	Place a jumper between D1 and D3, reprogram to N/O. Then remove the jumper and reboot the device.
No sound transmitted from the lift car to the call receiver.		<ul style="list-style-type: none"> • Connect a normal phone (e.g. Comphone) to the socket on the main unit and make a call to the car (press "1"). Alternatively, press "0" and wait for dial tone, then dial an external call. • If the sound transmission is OK in both directions, check if your emergency operator supports the chosen alarm type. • If no protocol is used, change the call type to "VOICE" using SafeLine Pro, SafeLine LYNX or program with *21*...*24*.

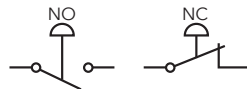

* , ** , *** Refer to chapter "Related Test Procedures"

Trouble-shooting main unit

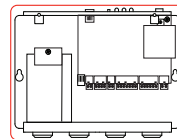

Problem	Possible cause(s)	Solution
Interfering noise when the call is connected.	If the main unit is installed on the car roof, the problem might be due to induction in the phone cable.	According to the telephone companies' regulations, the phone line must be installed in a separate cable. Do a noise test (**).
GSM noise.		<ul style="list-style-type: none">• Change the antenna position when a call is connected until you find the optimal antenna position.• Do not install the antenna near the main unit or close to the cabling.
Cannot dial out.	Broken line connection (LED 3 not flashing green). No money on refill SIM card.	<ul style="list-style-type: none">• Check the phone line connection (*).• Verify the SIM card by inserting it into a normal mobile phone.

* , ** , *** Refer to chapter "Related Test Procedures"

Trouble-shooting voice station

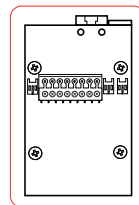

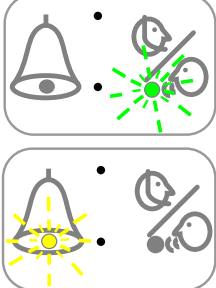
Problem	Possible cause(s)	Solution
The unit can not make an alarm call.	<ul style="list-style-type: none"> • At least one phone number and/or one ID code if using data identification must be programmed to make a call from the unit. • Refer to the parameter *11*. • Button not connected. • No voice unit connected. 	<ul style="list-style-type: none"> • Check wiring. • At least one voice station must be connected in order to make an alarm call.
No voice switching.	<ul style="list-style-type: none"> • If the main unit is installed on the car roof, the problem might be due to induction in the phone cable. 	<ul style="list-style-type: none"> • Place the bus cable in an environment with little external interference (***) Do a microphone test (***)
The pictogram LEDs are flashing quickly and simultaneously.	<ul style="list-style-type: none"> • The address switch is set to an invalid number (0, 7, 8, 9). Valid numbers are 1-6. • The address switch setting has been changed during operation. 	<ul style="list-style-type: none"> • Change the address switch to a valid number and restart the SL6 unit.
The pictogram LEDs are flashing alternately.	Bus communication error caused by any of the following reasons:	<ul style="list-style-type: none"> • Ensure that the address switches of the units are set to different numbers. • Ensure that the bus cable is not broken. • Check the bus cable installation.
	<ul style="list-style-type: none"> • Two or more units have the address switch set to the same number. • Bus cable broken. • Incorrect wiring of the bus cable. 	<ul style="list-style-type: none"> • Ensure that the address switches of the units are set to different numbers. • Ensure that the bus cable is not broken. • Check the bus cable installation.
The telephone beeps every 5 seconds.	This is to notify the passengers of the ongoing call (anti eavesdropping).	This is a normal procedure.

* , ** , *** Refer to chapter "Related Test Procedures"

Related test Procedures



* Telephone line check

1. Power up the unit.
 2. Lift the configuration handset.
 3. Wait for dial tone.
 4. Dial "0".
 5. Wait for new dial tone.
 6. Call another telephone and start a normal conversation.
 7. Hang up the configuration handset to end the call.
- If one of these steps is not successful the problem may not be with the unit, but due to incorrect wiring or faulty/missing telephone line.

** Noise check

1. Power up the unit.
 2. Lift the configuration handset.
 3. Wait for dial tone.
 4. Dial "0".
 5. Wait for new dial tone.
 6. Press a number on the keyboard.
 7. The dial tone stops and you hear silence.
 8. When you hear noise or humming, the problem may be due to induction in the phone cable.
 9. Hang up the configuration handset to end the call.
- According to the phone companies' regulations, the phone line must be installed on a separate cable. Redirect the cable by changing its position or finding another pair that is free of distortion, or use shielded pair when available. When none of these solutions apply, install a separate cable for the telephone line.

*** Microphone check

Call in to the SL6+ and press the following numbers on the caller's phone.

1. Press "7" to activate the car's microphone.
 2. Press "*" activates microphone of the caller.
 3. Press "4" for automatic switching of microphones.
- If you can speak through the microphones the hardware is OK.

Internal operational failures

If repeat alarms function is active - an active alarm will be re-sent each day as a reminder until problem is resolved. Applies only to battery failure, mic/speaker failure and stuck button alarms

Mains failure

When mains power has failed, an alarm will be sent after 15 minutes. When mains power returns, an alarm will also be sent.

Mic/speaker failure

Mic/speaker is tested once per day. If one/both fails, alarm will be sent.

Voice station failure

If the communication is disrupted an alarm will be sent. If communication returns, an alarm will also be sent.

Battery failure

Battery tests are performed every week. If a battery test fails, an alarm will be sent.

Stuck button

If pushed alarm button does not return to normal position, a stuck button alarm will be sent.

EU Declaration of Conformity

Product: Lift telephone
 Type / model: **SL6+**
 Article no: *SL6, *SL6-4G, *SL6-GSM, *SL6-GSM-BOARD, *SL6-MAINBOARD, *SL6-MINI, *SL6-MINI-4G, *SL6-MINI-GSM, *SL6 A+, *SL6 A+ MINI, *SL6 A+ 3G, *IF-BOARD-4G, *SL6-GSMR, *SL6-MINI-GSMR
Including voice stations:
 *SLB3-COP, *SLB3-REC-PIC, *SLB3-REC-PIC-B, *SLB3-SM-PIC, *SLB3-SM-PIC-B, *SLB3-SM-PIC-L, *SLB3-SMD-PIC, *SLB3-SMD-PIC-B, *SLB3-REC-BL, *SLB-COP, *SLB-COP2, *SLB-COP2-L, *SLB-COP-L, *SLB-COP-SEP, *SLB-IF1, *SLB-IF2, *SLB-RD, *SLB-RD-BUT, *SLB-RD-BL, *SLB-RD-BEL, *SLB-REC, *SLB-REC-FIRE, *SLB-REC-FIRE02, *SLB-REC-FIREK, *SLB-REC-FIREK02, *SLB-REC-LED, *SLB-REC-PIC, *SLB-REC-PIC-BUT, *SLB-SM, *SLB-SM-LED, *SLB-SM-PIC, *SLB-SM-PIC-BUT, *SLB-SM-PIC-LIGH, *SLB-SMD-PIC-BUT, *SLBR-COP, *SLBR-SM-PIC, *SLBR-SM-PIC-B, *SLBR-REC-PIC, *SLBR-REC-PIC-B, *SLBR-REC-PIC-B2, *SLBR-REC-PIC3, *SLBR-RD-B-L
 Manufacturer: SafeLine Sweden AB
 Year: 2020

We herewith declare under our sole responsibility as manufacturer that the products referred to above complies with the following EC Directives:

Directives

Radio Equipment (RED):	2014/53/EU	(Including EMC 2014/30/EU, LVD 2014/35/EU)
RoHS 2:	2011/65/EU	
Lift	2014/33/EU	(Annex 4.5 & 4.9)

Standards applied

EN 81-20:2014	Lift: Safety & Technical requirements
EN 81-28:2003	Lift: Remote alarm on passenger and goods passenger lifts
EN 81-70:2003/A1:2004	Lift: Accessibility to lifts for persons including persons with disability
EN 81-72:2003	Lift: Firefighters lifts
EN 12015:2014	EMC: Emission, Electromagnetic compatibility
EN 12016:2013	EMC/Lifts: Immunity, Electromagnetic compatibility
EN 62368-1:2014/AC:2015	LVD: Information Technology Equipment
EN 50581:2012	RoHS: Technical doc. for assessment of restriction of RoHS.

For RED 2014/53/EU, an "EU-Type Examination procedure" has been applied and is certified by notified body:

TÜV AUSTRIA SERVICES GMBH, Notified Body Nr: 0408, Certificate Nr: INE-AT/EMV-18/138

Module	Notified body	Address	NB nr	Test nr
CONNECTable	FORCE Technology	Venlighedsvej 4, 2970 Hørsholm	0199	119-24187-1, 119-24187-2
TRM-5	TÜV AUSTRIA SERVICES GMBH	Deutschestraße 10, 1230 Wien	0408	INE-AT/EMV-18/138
N.A.	TÜV AUSTRIA SERVICES GMBH	Deutschestraße 10, 1230 Wien	0408	INE-AT/IT-18/109
TRM-5	Phoenix testlab GmbH	Königswinkel 10, D-32825 Blomberg, Germany	0700	13-113995
GL865-Dual V3	Dekra Test & Cert	Parque Tecnológico de Andalucía / SeveroOchoa 2,	1909	53051 RBN.001
LE910-EU V2	Dekra Test & Cert	29590 Spain	1909	52382 RCB.001

with the supporting assessments:

Standards applied

EN 60950-1:2006+A11:2009+A1:2010+A12:2011+A2:2013
EN 62311:2008
EN 301 489-1 v2.1.1 + EN 301 489-52v1.1.0 Draft
EN 301 489-17 V3.1.1
EN 301 511 v12.5.1
EN 301 908-1v11.1.1 /-2v11.1.1 /-13v11.1.1
EN 300 328 V2.1.1

Article of Directive 2014/53/EU

3.1 (a): Health and safety of the user
3.1 (B): Electromagnetic Compatibility
3.2: Effective use of spectrum allocated

Firmware used during assessment

Triorail TRM-5:	Rev. 03.016 / Rev. 03.017 / Rev. 03.019 / Rev. 03.025
GL865-Dual V3:	16.00.152 / 16.01.150 / 16.01.153
LE910-EU V2:	20.00.402
SafeLine SL6	4.50

Tyresö, 2020-09-08

 Lars Gustafsson,
 Technical Manager, R&D, SafeLine Group

Antennvägen 10, 13548 Tyresö, Sweden
 +46 (0)8-447 79 32, www.safeline-group.com

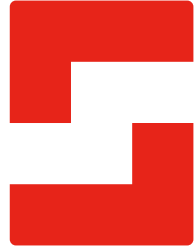

SafeLine Headquarters

Antennvägen 10 · 135 48 Tyresö · Sweden
Tel.: +46 (0)8 447 79 32 · info@safeline.se
Support: +46 (0)8 448 73 90

SafeLine Denmark

Vallensbækvej 20A, 2. th · 2605 Brøndby · Denmark
Tel.: +45 44 91 32 72 · info-dk@safeline.se

SafeLine Norway

Solbråveien 49 · 1383 Asker · Norway
Tel.: +47 94 14 14 49 · post@safeline.no

SafeLine Europe

Industrieterrein 1-8 · 3290 Diest · Belgium
Tel.: +32 (0)13 664 662 · info@safeline.eu
Support: +32 (0)4 85 89 08 95

SafeLine Deutschland GmbH

Kurzgewannstraße 3 · D-68526 Ladenburg · Germany
Tel./Support: +49 (0)6203 840 60 03 · sld@safeline.eu

SafeLine Group UK

Unit 47 · Acorn Industrial Park · Crayford ·
Kent · DA1 4AL · United Kingdom
Tel.: +44 (0) 1322 52 13 96 · info@safeline-group.uk

SafeLine is a registered trademark of SafeLine Sweden AB. All other trademarks, service marks, registered trademarks, or registered service marks are the property of their respective owners.